

## FAQ of RAY5 40W series Laser Engraver

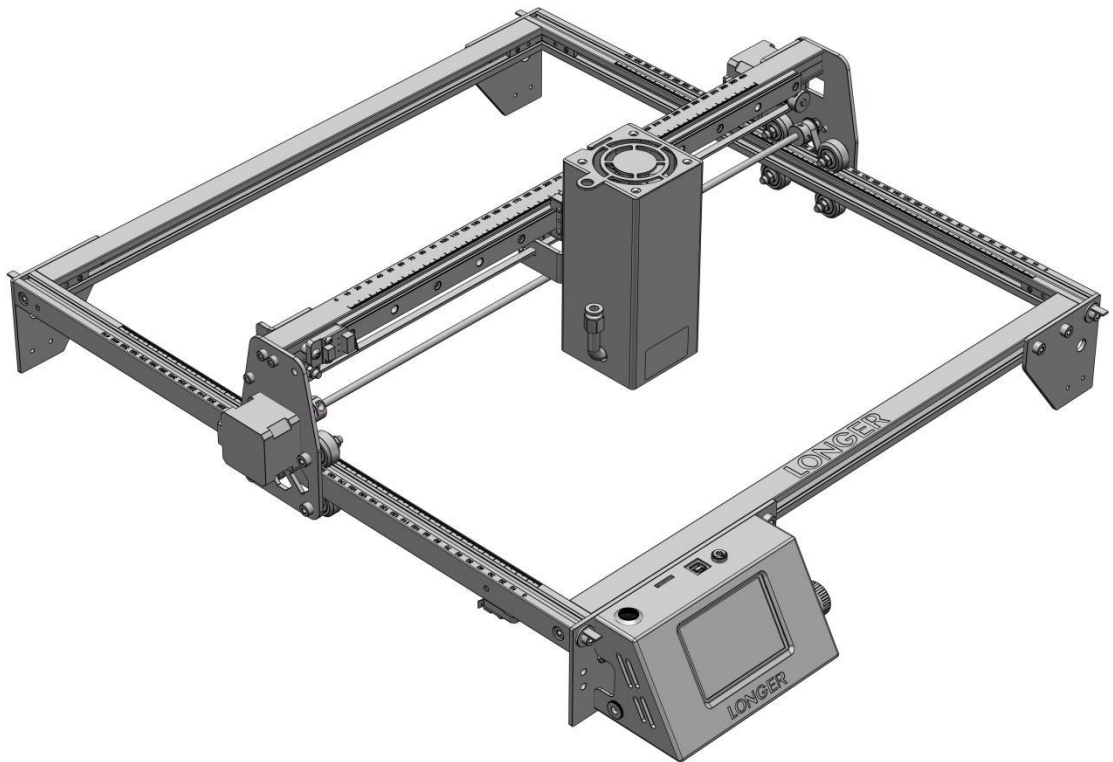

**Shenzhen Longer Technology Co., Ltd.**

## CONTENT

1. How to update the firmware .....	1
2. Turn on the switch but it does not turn on .....	3
3. Unable to connect to LightBurn or LaserGBRL .....	3
4. How to adjust the graphics position in LaserGRBL .....	7
5. LaserBurn APP cannot connect to WIFI .....	7
6. There are error or alarm during engraving .....	9
7. The laser module keeps hitting the edge when returning to HOME ...	10
8. The engraved patterns are unclear .....	11
9. How to transfer photos from PC to LaserBurn APP .....	13

## 1. How to update the firmware

### 1) Update by ESPTool Web

Enter <https://espressif.github.io/esptool-js/> in the browser. This webpage can connect to the serial port to flash the firmware online. Select the baud rate 115200 and connect to the CH340 serial port, then Click “Erase Flash” first, then enter the Flash address 0x0 and select the firmware, then click Program to start burning.

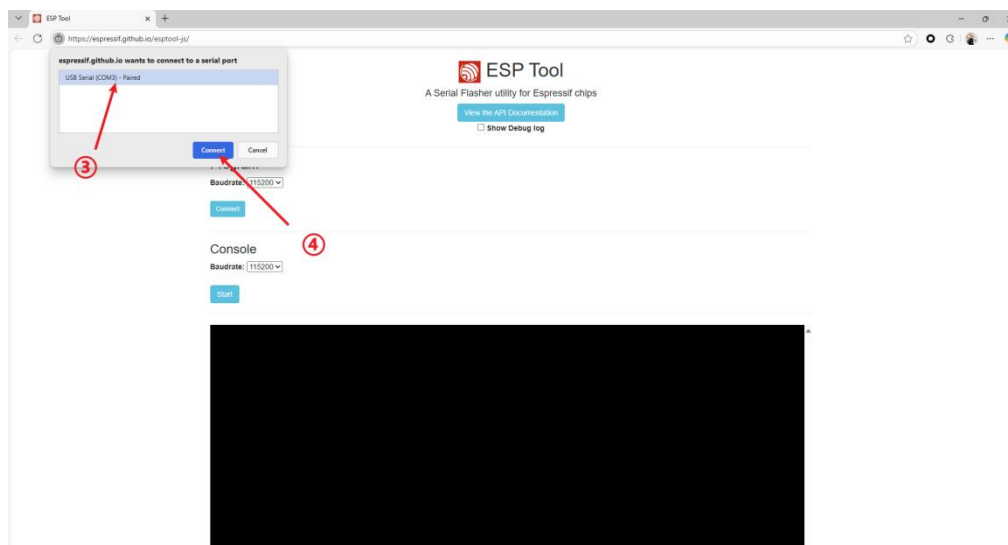
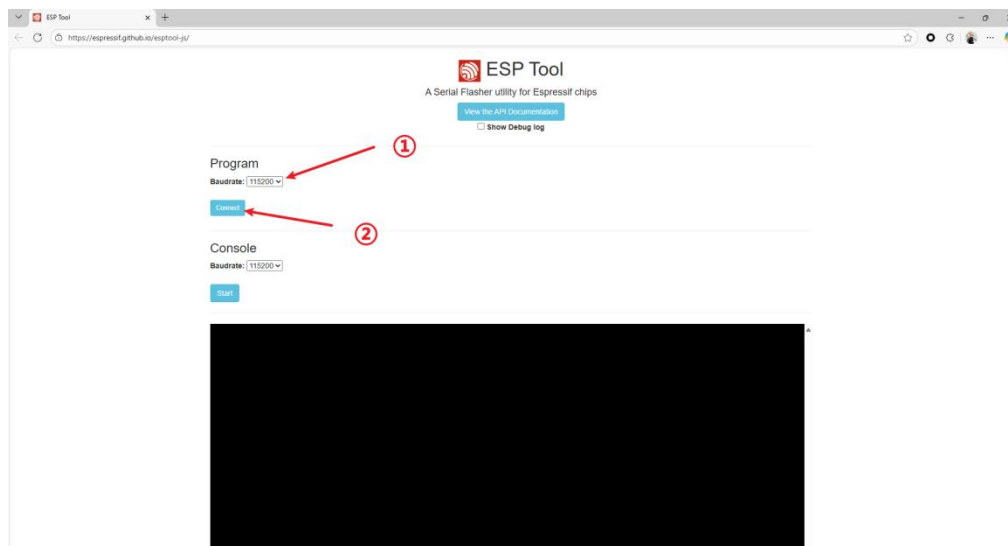

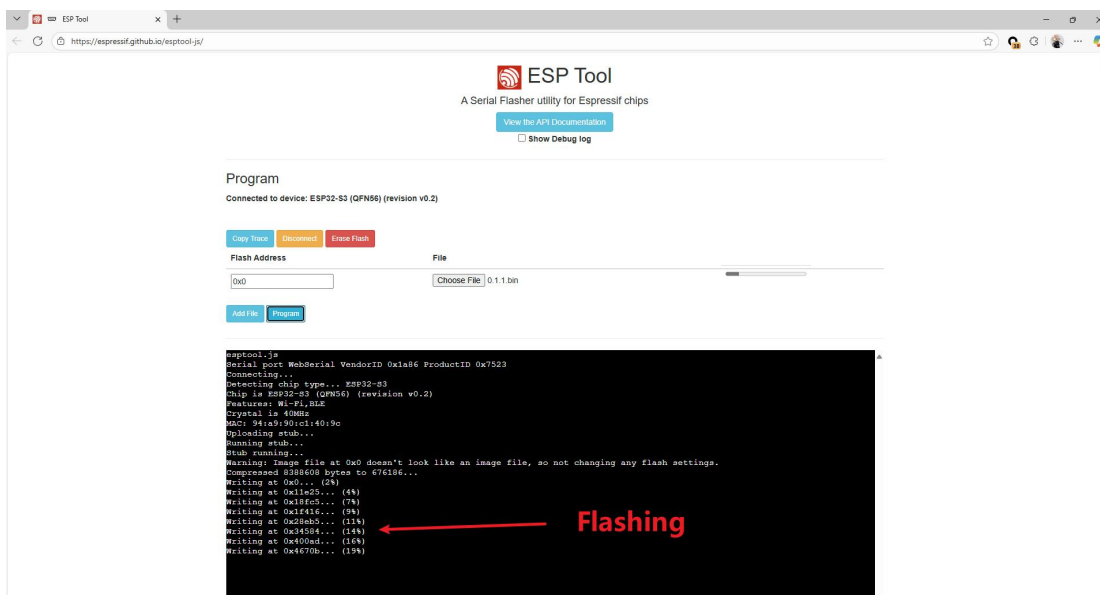
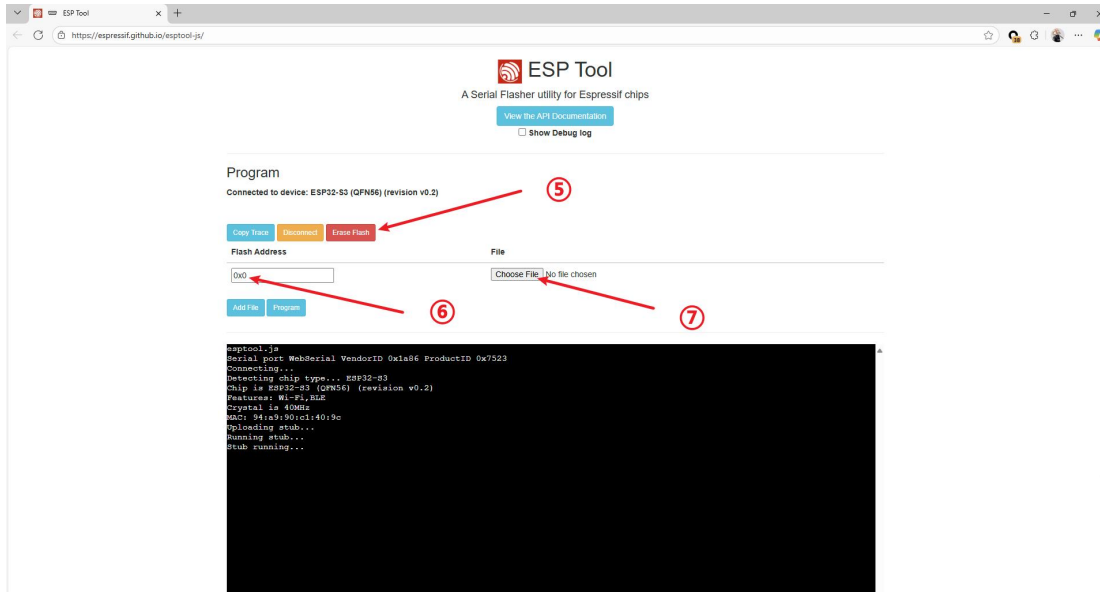

## 2) Update by LaserBurn APP

After the engraving machine is connected to the LaserBurn App, click Me→About→Firmware Update→RAY5 40W to upgrade the firmware.

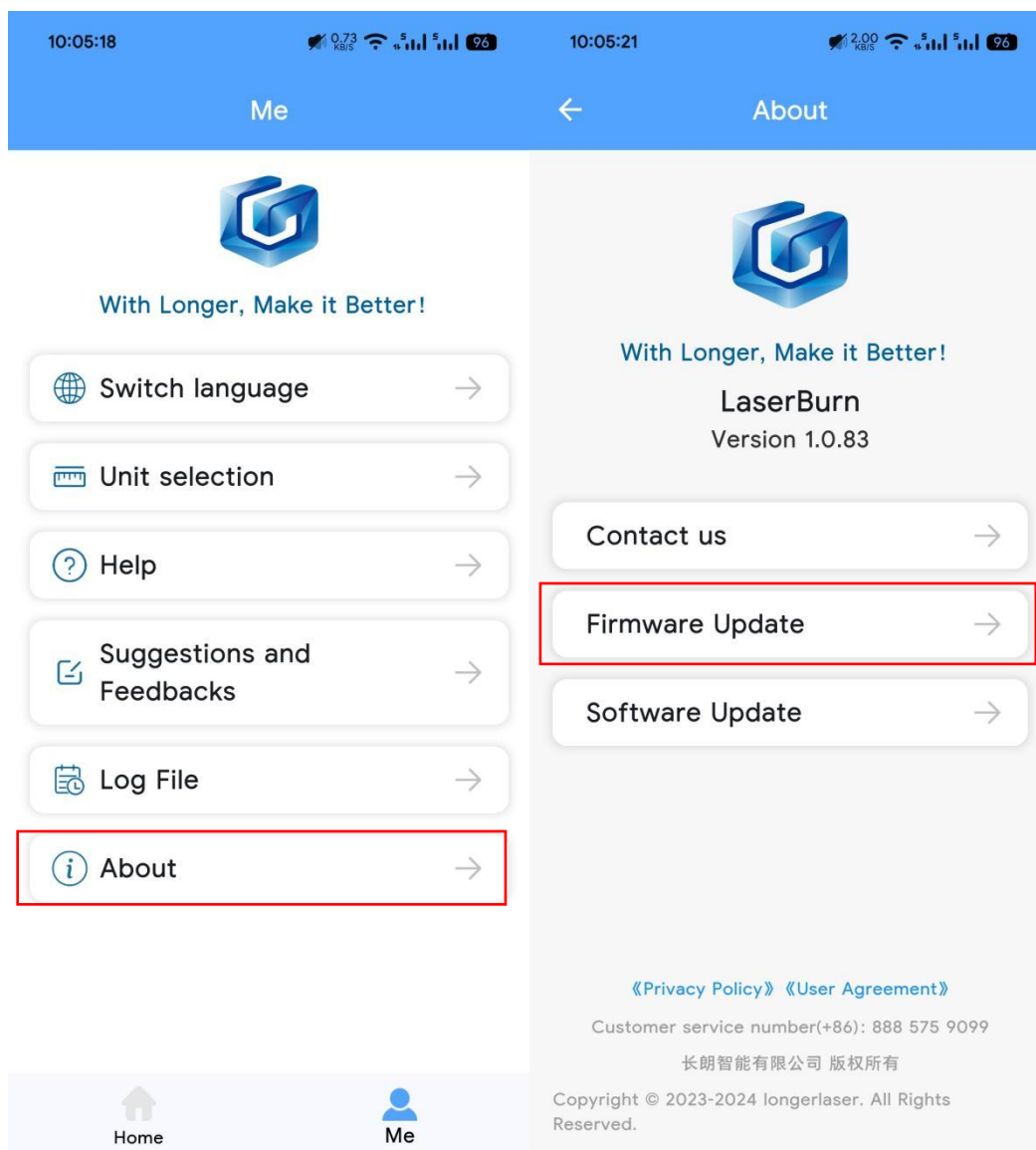

## 2. Turn on the switch but it does not turn on

- 1) Check if the emergency stop switch is pressed. If it is pressed, turn it clockwise to open it.
- 2) Check if the power adapter is connected.

## 3. Unable to connect to LightBurn or LaserGBRL

- 3) Can't find CH340 driver

For [Windows](#) system, it needs to right-click the computer and select

Manage, click Device Manager, click to expand Ports (COM & LPT), find the port corresponding to the [CH340 driver](#), and then select this port in LightBurn or LaserGRBL.

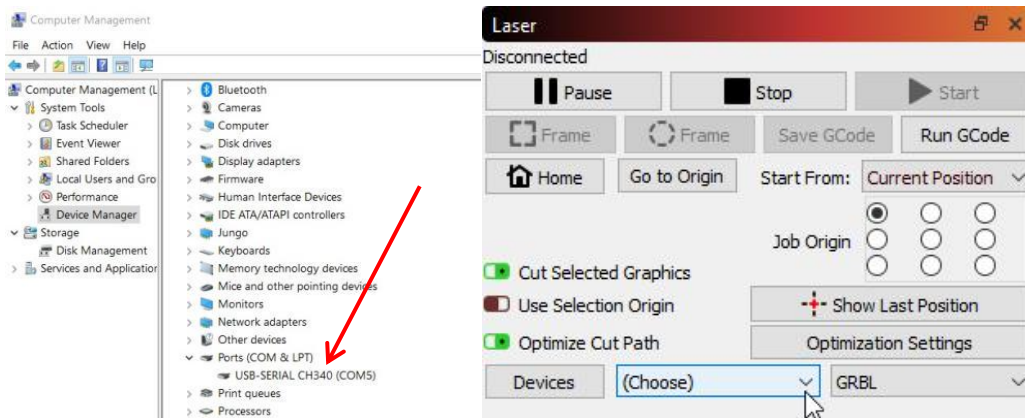

For **MacOS**, please go to About this Mac > Overview > System Report, select USB under Hardware, there will be USB Serial if the driver is installed automatically, and select [cu.wchusbserial14230](#) port in the LightBurn or LaserGRBL.

If no ports are listed in the expand Ports (COM & LPT), it means that no engravers were found, which could mean that it is not plugged in correctly, isn't powered, or the PC is missing a driver. It needs to download CH340 driver from the link and double click it to install:

<https://drive.google.com/drive/folders/1Sc-TKuez-mz--38Vp6DeL-pGmQcQdHW4>.

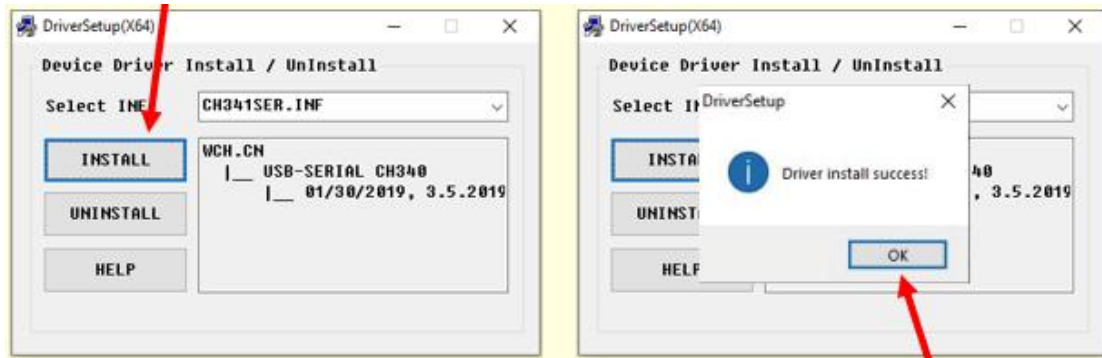

How to install CH340 driver of LightBurn for MacOS Sequoia system:

<https://www.youtube.com/watch?v=JX-XsjLFei0>

How to install CH340 driver of LightBurn for MacOS system:

<https://www.youtube.com/watch?v=FBd1uEA9QUw>

4) CH340 driver port is occupied

Before connecting, please make sure that the CH340 port is not occupied by software such as serial communication tools, cura, etc.

5) The Baud rate setting error

The Baud rate should be set to 115200. The wrong baud rate will cause the connection to the engraving machine to fail.

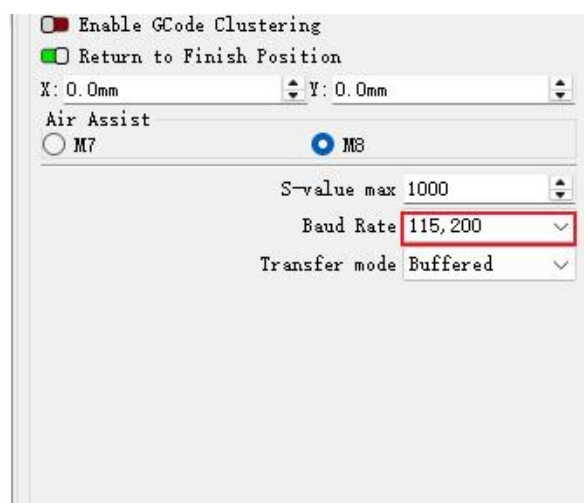

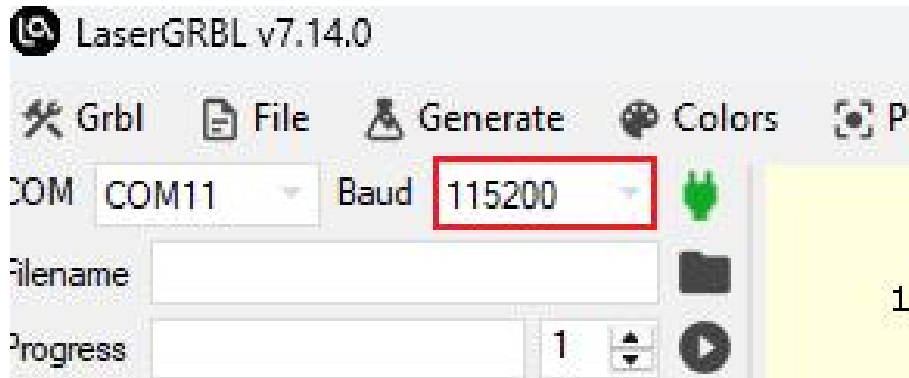

6) The configuration file is not imported or damaged

For LightBurn, click "[Devices](#)" in the laser control module to import the engraver. Click '[Import](#)', select the [RAY5 mini.lbdev](#) file, and click OK to add the RAY5 mini configuration to LightBurn. The macro commands will be successfully added in the Console window and RAY5 mini device would appear in the list of devices to the right of the 'Devices' button in the Laser window when the configuration file is imported successfully.

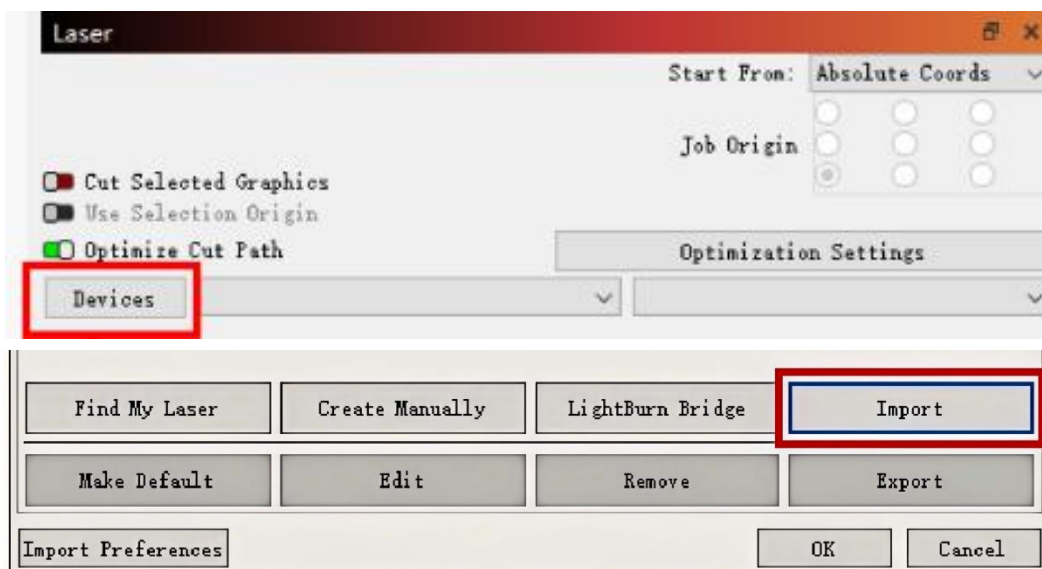

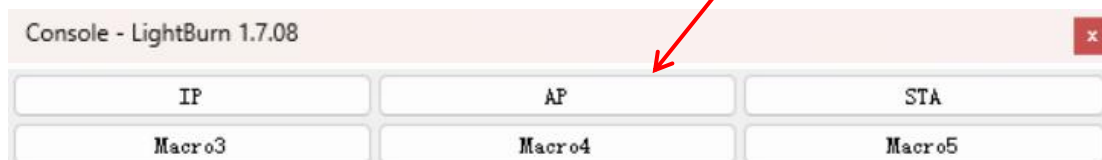

#### 4. How to adjust the graphics position in LaserGRBL

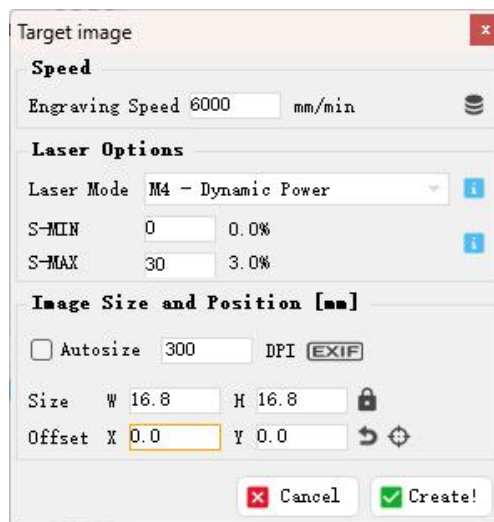

Click File > Open File to add the design to be engraved, adjust the offset of X and Y in the target image window to change the position of the graphics to make sure which is in the range of 390\*385mm.

#### 5. LaserBurn APP cannot connect to WIFI

1) Update the app to the latest version

Please search for "LaserBurn" in Google play or Apple store to download and update to the latest version.

2) APP is not allowed to discover device's location

When run the app for the first time, select **ALLOW ONLY WHILE IN USE** when prompted 'Allow LaserBurn to access this device's location?', or the LongerLaser\_XXXX WIFI can not be found. If have

already selected DENY, it needs to change the app's location discovery permission in Settings.

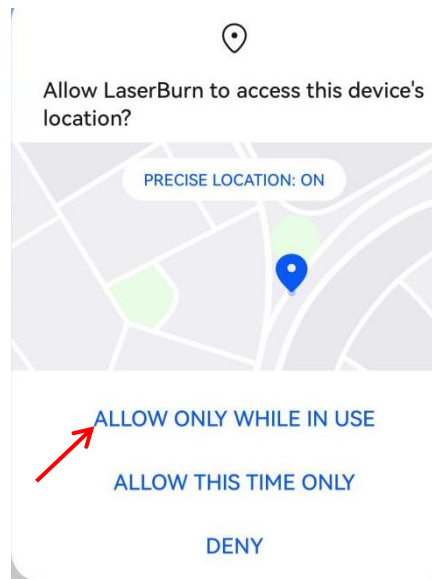

### 3) Reset the WIFI

If WIFI of LongerLaser\_XXXX can not be found, please click "AP" in the Lightburn macro definition button to switch the network mode, then search the WIFI list again.

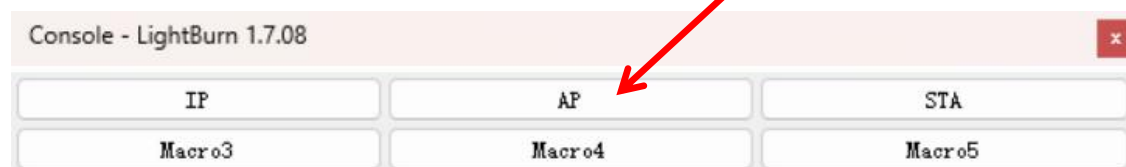

### 4) Not connected to the same router or not 2.4G WIFI

In STA mode, it needs to connect the [engraver and mobile phone to the same router](#) WIFI. Make sure it is [2.4G WIFI](#). 5G WIFI is not supported yet.

### 5) WIFI signal is too weak

Switch to a router with better signal strength.

## 6. There are error or alarm during engraving

1) Manually moving the laser position during engraving causes limit triggering.

```
ALARM:1
Hard limit triggered. Machine position is likely lost due to sudden and immediate halt. Re-homing is highly recommended.
On or near line 0:
Stream completed in 0:00
```

2) When you click Stop during engraving, this error will be reported, which is normal.

```
ALARM:3
Reset while in motion. Grbl cannot guarantee position. Lost steps are likely. Re-homing is highly recommended.
```

3) When engraving an image or vector filling at the current position, if the overscan function is turned on, the soft limit may be triggered and the engraving may not be possible. You need to change the coordinates to absolute coordinates. If you do not change the coordinate system, then reduce the pattern and put it in the middle, or turn off the overscan function.

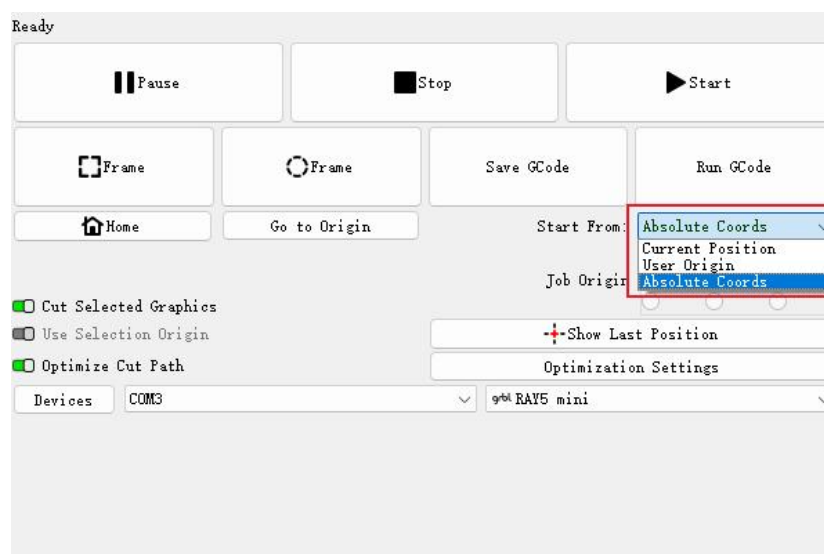

```

ALARM:2
G-code motion target exceeds machine travel. Machine position safely retained. Alarm may be
unlocked. (Right-click the 'Devices' button to reset the connection)
On or near line 0:
Job halted
Stream completed in 0:00

```

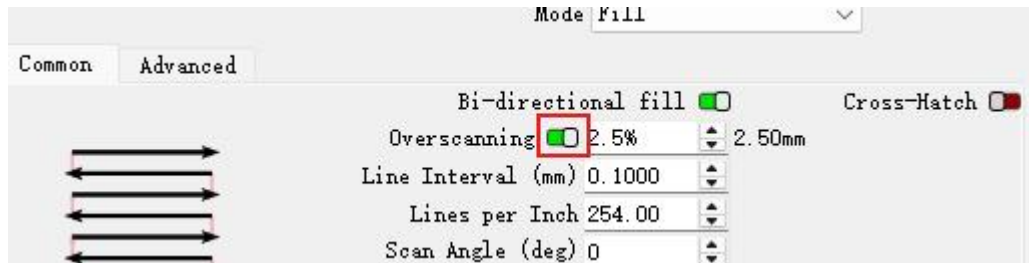

4) The machine continuously detects the signal of the limit switch, resulting in a zeroing abnormality. The solution is to confirm that the XY axis does not hit the limit switch after the XY axis completes zeroing.

```

ok
ALARM:8
Homing fail. Cycle failed to clear limit switch when pulling off. Try increasing pull-off
setting or check wiring.
ok
[0:32mI (1206941) gpio: GPIO[47]| InputEn: 1| OutputEn: 0| OpenDrain: 0| Pullup: 1|
 Pulldown: 0| Intr:0 [0m
[0:32mI (1206942) gpio: GPIO[48]| InputEn: 1| OutputEn: 0| OpenDrain: 0| Pullup: 1|

```

## 7. The laser module keeps hitting the edge when returning to HOME

- 1) Check if the limit cable is loose. If it is loose, tighten the cable.
- 2) Check whether the limit position is too far back. When Homing, the laser cannot touch the limit and keeps hitting the edge. If so, adjust the limit position so that it is triggered just when returning to Home.

## 8. The engraved patterns are unclear

The failures of laser engraving mark is unclear may be due to incorrect focus, mismatch of parameters and materials, etc. Please refer to the following steps to check.

1) First make sure the focus is correct.

Use the focus block to adjust the focal length.

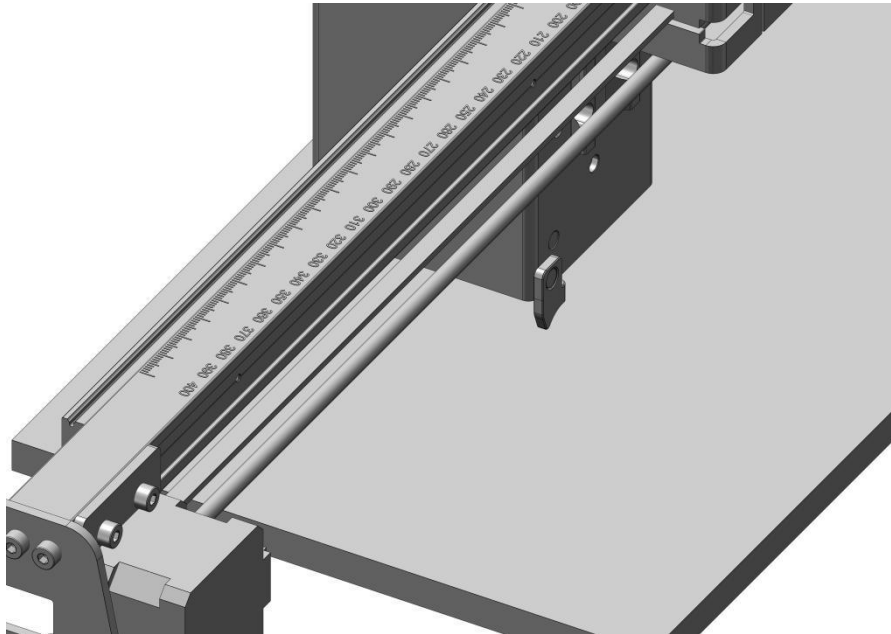

2) Check if the S value in Lightburn

That is click Lightburn-Edit-Device Setting and check whether the S-value MAX is 1000.

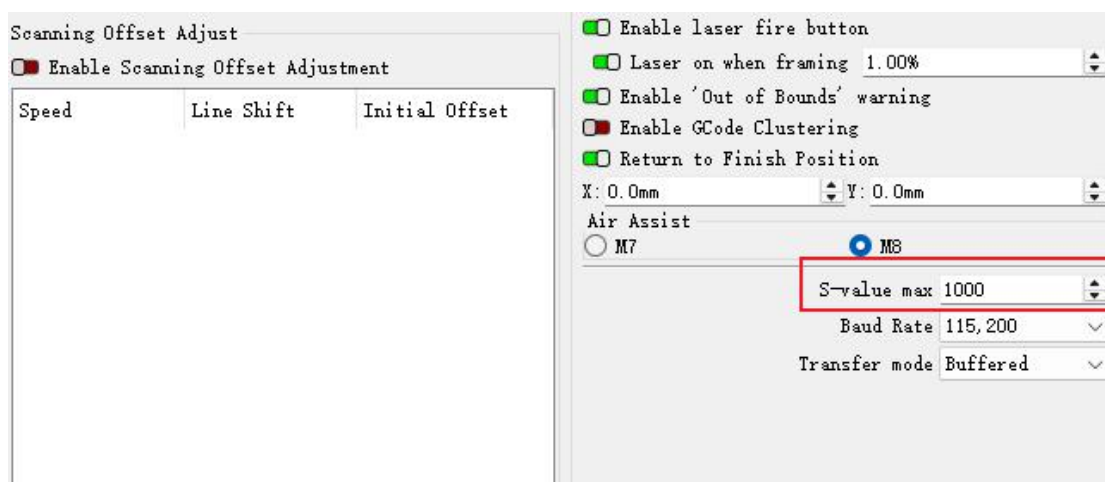

### 3) Check the parameters

Check whether the engraving parameters are correct, especially the speed unit, please refer to the parameter table in the Official Website. And for the LaserGRBL software, the value of S-MAX is 10 times the target laser power, such as when the laser power is 100%, S-MAX needs to be set to 1000%

### 4) Turn on the constant power

When editing parameters, make sure the laser mode is set to constant power mode, as shown in the figure.

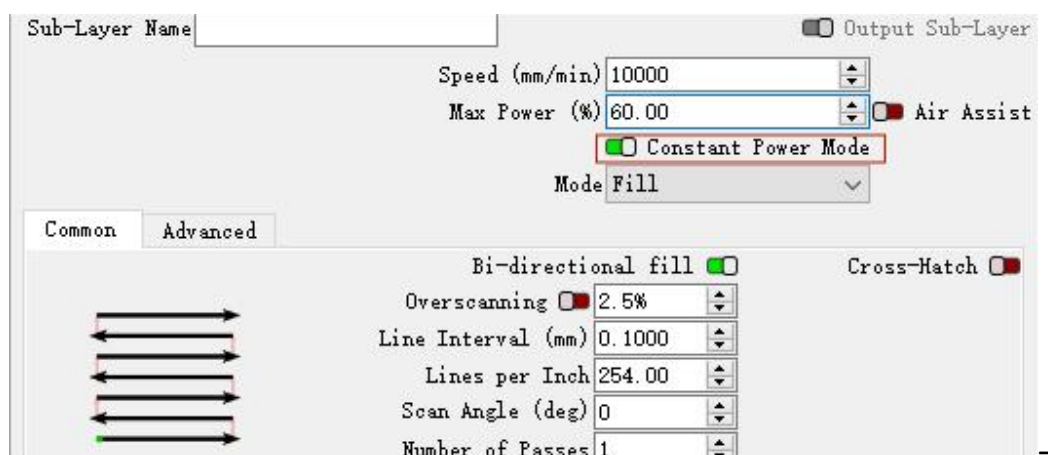

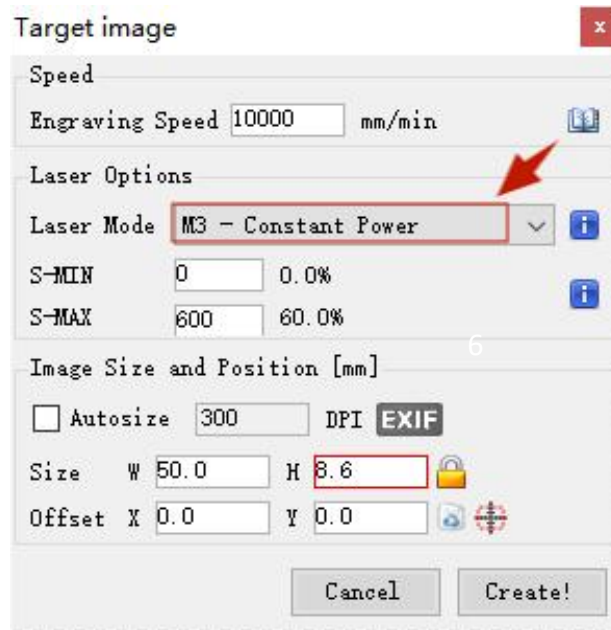

## 5) Check window lens

Check whether the window mirror of the laser head unit is contaminated. If there is contamination, it is recommended to use lens cleaning paper or a dust-free cloth soaked in alcohol to wipe gently to avoid damaging the coating.

## 9. How to transfer photos from PC to LaserBurn APP

### 1) Transfer photos from PC to phone

For **iPhone**: Connect iPhone using a USB-C cable, In the iTunes app on the PC , click the Devices button near the top left of the iTunes window.

Click Photos. Select Sync Photos, then choose an album or folder from the pop-up menu.

For **android**: With a USB cable, connect your device to your

computer. On your device, tap the "Charging this device via USB" notification. Under "Use USB for," select File Transfer. A file transfer window will open on your computer. Use it to drag files.

## 2) Add photos to LaserBurn APP

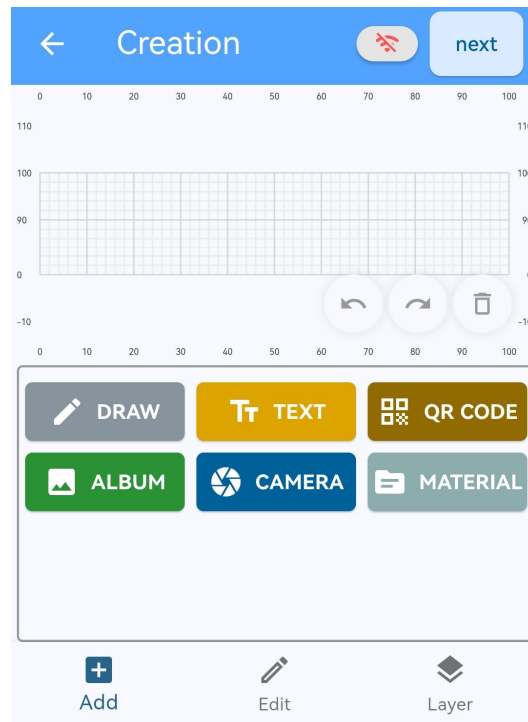

Run LaserBurn, click Creation > ALBUM to add photo from phone.